

# TEMPERATURE SENSORS, WIRE AND CABLE

## חיישנים למדידת טמפרטורה

### תוכן העניינים INDEX

- |        |                                    |
|--------|------------------------------------|
| 1.     | חיישן מוט עם מחבר                  |
| 2.     | חיישן מוט עם כבל הארכה             |
| 3.     | חיישן עם ביונט וקפיץ               |
| 4.     | חיישן מוט עם ראש חיבור אטום        |
| 5.     | חיישן עם ראש תעשייתי וצינור מגן    |
| 6.     | חיישן להחלפה                       |
| 7-8.   | כיסוי מגן                          |
| 9.     | חיישן לשטח, חיישן לצנרת            |
| 10.    | חוטי טרמוקופל מבודדים וכבלי השוואה |
| 11.    | מחברים ואביזרים לטרמוקופל          |
| 12.    | גששים ניידים                       |
| 13-14. | גששים ניידים לשטח                  |

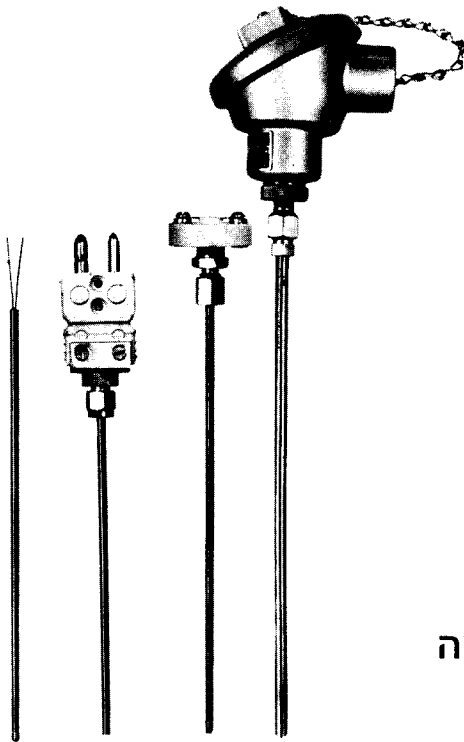

**M.R.C. LTD.**

MAIN OFFICE: 84 HAHISTADRUTH ST., HOLON

**ISO 9002 CERTIFIED**

משרד ראשי: ההסתדרות 84 חולון 58415

טלפון: 03-5595252, 03-5593105, פקס: 03-5594529

# MINERAL INSULATED THERMOCOUPLES

## חיישן טמפרטורה מוט עם מחבר או חוטי יציאה קשיחים

הגדרת דגם להזמנה - ORDERING CODE

	T1	<input type="checkbox"/>	<input type="checkbox"/>	<input type="checkbox"/>	<input type="checkbox"/>	<input type="checkbox"/>	<input type="checkbox"/>	<input type="checkbox"/>	<input type="checkbox"/>
<b>Sensor Type</b> K, J, T, E, N, R, S	סוג הרגש								
<b>Sensor Length - mm</b>	אורך הרגש								
<b>Sensor Diameter</b> 1/16", 1/8", 3/16", 1/4" 1.5 mm, 3.2 mm, 4.8 mm, 6.4 mm	קוטר הרגש								
<b>Sheath Material</b> A. Inconel 600 B. S.S. 316 C. S.S. 310 X. Others on request	המעטפת								
<b>Junction</b> E. Exposed U. Ungrounded G. Grounded	צומת חמה								
<b>No. of elements</b> S. Single element D. dual element	מספר האלמנטים								
<b>Connection</b> 1. Standard Plug 2. Standard Jack 3. High temp Plug 4. High temp Jack 5. Mini Plug 6. Mini Jack 7. None	סוג החיבור								
<b>Max Temperature</b>	טמפרטורת עבודה מכסימלית								

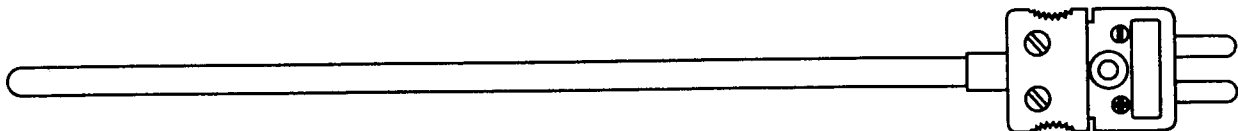

מחבר הידוק (1/2 NPT, 1/4)  
מנירוסטה או פליז

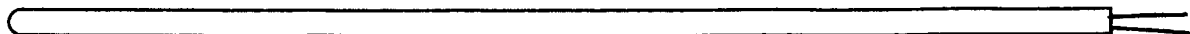
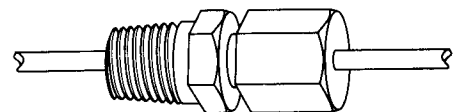

**M.R.C. LTD.**

TEL. 03-5593105, 03-5595252, Fax. 03-5594529

# THERMOCOUPLES & RTD<sub>s</sub> WITH EXTENSION CABLE

## חיישן טמפרטורה מוט עם כבל מאריך

הגדרת דגם להזמנה - ORDERING CODE

	T2A	<input type="checkbox"/>	<input type="checkbox"/>	<input type="checkbox"/>	<input type="checkbox"/>	<input type="checkbox"/>	<input type="checkbox"/>	<input type="checkbox"/>	<input type="checkbox"/>	<input type="checkbox"/>	<input type="checkbox"/>
	T2B	<input type="checkbox"/>	<input type="checkbox"/>	<input type="checkbox"/>	<input type="checkbox"/>	<input type="checkbox"/>	<input type="checkbox"/>	<input type="checkbox"/>	<input type="checkbox"/>	<input type="checkbox"/>	<input type="checkbox"/>
<b>Sensor Type</b> K, J, T, E, N, R, S, PT100 2W/3W/4W	סוג הרגש										
<b>Sensor Length - mm</b>	אורך הרגש										
<b>Sensor Diameter</b> 1/16", 1/8", 3/16", 1/4" 1.5 mm, 3.2 mm, 4.8 mm, 6.4 mm	קוטר הרגש										
<b>Sheath Material</b> A. Inconel 600 B. S.S. 316 C. S.S. 310 X. Others on request	המעטפת										
<b>Junction</b> E. Exposed U. Ungrounded G. Grounded	צומת חמה										
<b>No. of elements</b> S. Single element D. dual element	מספר האלמנטים										
<b>Cable Type</b> T. Teflon F. Fiberglass Overbraid P. PVC L. Fiberglass	סוג כבל יציאה										
<b>Cable length - cm</b>	אורך כבל יציאה										
<b>Connection</b> 1. Standard Plug 2. Standard Jack 5. Mini Plug 6. Mini Jack 7. None	סוג החיבור										
<b>Max Temperature</b>	טמפרטורת עבודה מכסימלית										



דגם T2A - עם חיבור קפיץ



דגם T2B

**M.R.C. LTD.**

TEL. 03-5593105, 03-5595252, Fax. 03-5594529

# TEMPERATURE SENSOR WITH BAYONET & SPIRAL

## חיישן טמפרטורה עם ביונט וקפיץ לתעשיית הפלסטיק

הגדרת דגם להזמנה - ORDERING CODE

T3		<input type="checkbox"/>	<input type="checkbox"/>	<input type="checkbox"/>	<input type="checkbox"/>	<input type="checkbox"/>	<input type="checkbox"/>
<b>Sensor Type</b> J, K, E, PT 100 2W, PT 100 3W	סוג הרגש						
<b>Sensor Length - mm</b>	אורך הרגש						
<b>Sensor Diameter</b> 1. 1/4" 6.4 mm 2. 3/16" 4.8 mm 3. 3/8" 9.5 mm 4. SPECIAL	קוטר הרגש						
<b>Cable Type</b> 1. Teflon 2. Fiberglass 3. Fiberglass Overbraid	סוג כבל יציאה						
<b>Cable Length - cm</b>	אורך כבל יציאה						
<b>Max. Temperature</b>	טמפרטורת עבודה מכסימלית						

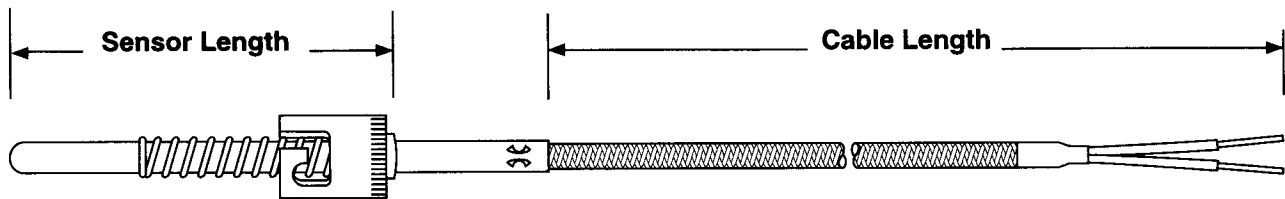

**M.R.C. LTD.**

TEL. 03-5593105, 03-5595252, Fax. 03-5594529

# THERMOCOUPLES & RTD<sub>s</sub> WITH CONNECTION HEAD

## חיישן טמפרטורה מוט עם ראש חיבור אטום

הגדרת דגם להזמנה - ORDERING CODE

	T4								
<b>Sensor Type</b> סוג הרגש K, J, T, E, N, R, S, PT100 2W/3W/4W									
<b>Sensor Length - mm</b> אורך הרגש									
<b>Sensor Diameter</b> קוטר הרגש 1/16", 1/8", 3/16", 1/4" 1.5 mm, 3.2 mm, 4.8 mm, 6.4 mm									
<b>Sheath Material</b> המעטפת A. Inconel 600 B. S.S. 316 C. S.S. 310 X. Others on request									
<b>Junction</b> צומת חמה E. Exposed U. Ungrounded G. Grounded									
<b>No. of elements</b> מספר האלמנטים S. Single element D. dual element									
<b>Connection Head</b> סוג ראש החיבור A. Plastic B. Aluminum									
<b>Connection Options</b> תבריג לתהליך 1. 1/2" NPT 2. 1/2" BSP 3. 3/4" NPT 4. 3/4" BSP 5. No connection									
<b>Max Temperature</b> טמפרטורת עבודה מכסימלית									

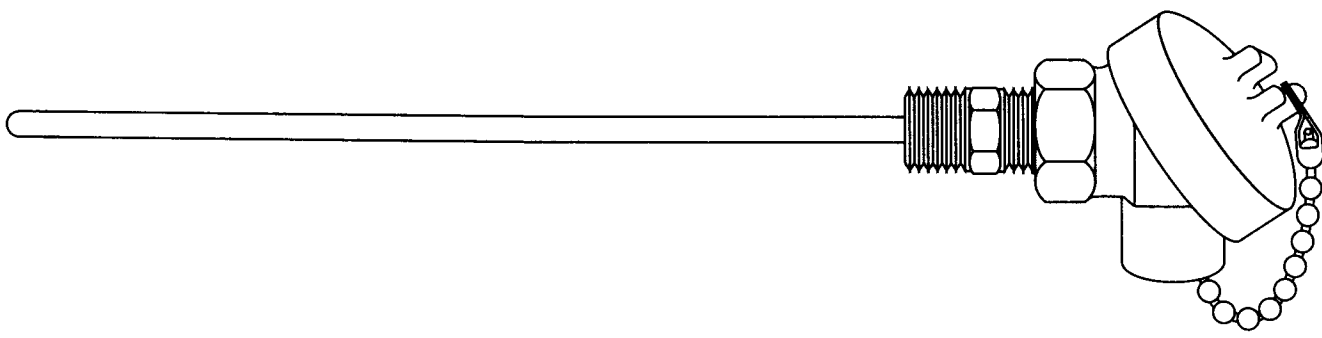

**M.R.C. LTD.**

TEL. 03-5593105, 03-5595252, Fax. 03-5594529

# THERMOCOUPLES WITH CONNECTION HEAD & PROTECTION TUBE

## חיישן טמפרטורה מוט עם ראש תעשייתי וצינור מגן לתעשייה הכבדה

הגדרת דגם להזמנה - ORDERING CODE

		T5	<input type="checkbox"/>	<input type="checkbox"/>	<input type="checkbox"/>	<input type="checkbox"/>	<input type="checkbox"/>	<input type="checkbox"/>	<input type="checkbox"/>
<b>Sensor Type</b> K, J, T, E, N, R, S	סוג הרגש								
<b>Sensor Length - mm</b>	אורך הרגש								
<b>Sensor Diameter</b>	קוטר הרגש								
<b>Protection Tube Type</b> 1. Ceramic Mullite 2. Ceramic Alsint 99.8% Al <sub>2</sub> O <sub>3</sub> 3. Cast Iron 4. Silicon Carbide 5. Special	סוג צינור מגן								
<b>No. of elements</b> S. Single element D. dual element	מספר אלמנטים								
<b>Connection</b> 1. 1/2" NPT 2. 1/2" BSP 3. 3/4" NPT 4. 3/4" BSP	תבריג לתהליך								
<b>Max Temperature</b>	טמפרטורת עבודה מכסימלית								



**Metal Tube**

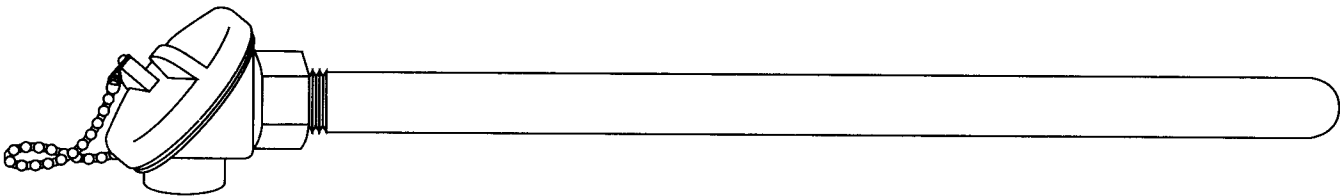

**Cast Iron Tube**

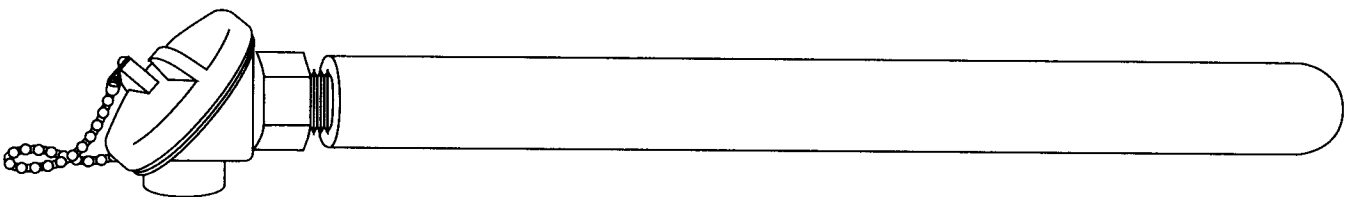

**M.R.C. LTD.**

TEL. 03-5593105, 03-5595252, Fax. 03-5594529

# THERMOCOUPLE & RTD<sub>s</sub> REPLACEMENT INSERT

## חיישן מוט להחלפה בגששים עם ראש תעשייתי

הגדרת דגם להזמנה - ORDERING CODE

	T6
<b>Sensor Type</b> סוג הרגש K, J, T, E, N, R, S, PT100 2W PT100 3W PT100 4W	□
<b>Sensor Length - mm</b> אורך הרגש	□
<b>Sensor Diameter</b> קוטר הרגש 1/16", 1/8", 3/16", 1/4" 1.5 mm, 3.2 mm, 4.8 mm, 6.4 mm	□
<b>Sheath Material</b> המעטפת A. Inconel 600 B. S.S. 316 C. S.S. 310 X. Others on request	□
<b>Junction</b> צומת חמה E. Exposed U. Ungrounded G. Grounded	□
<b>No. of elements</b> מספר האלמנטים S. Single element D. dual element	□
<b>Max Temperature</b> טמפרטורת עבודה מכסימלית	□



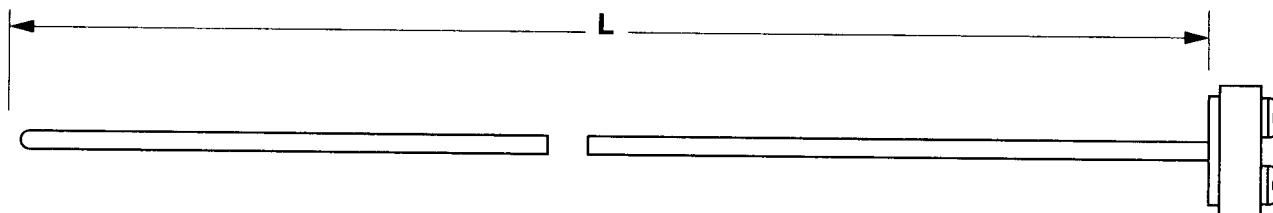

**M.R.C. LTD.**

TEL. 03-5593105, 03-5595252, Fax. 03-5594529

הגדרת דגם להזמנה - ORDERING CODE

	TW								
<b>Style</b> 1, 2, 3, 4, 5, 6	סוג								
<b>L - Length - (Inches)</b>	אורך								
<b>Thermowell - Material</b> 1. 304 SS 2. 316 SS 3. Monel 4. Hastelloy C-276	חומר הכיסוי								
<b>P - Process Connection Size (Inch)</b> 1. 3/4 NPT 2. 1 NPT 3. Other	תבריק לתהליך								
<b>Flange Rating (lbs)</b> 0. No flange 1.150      5.1500 2.300      6.2500 2.300      X.Other 3.600 4.900	תקן אגן								
<b>T - Lag (Inches)</b>									
<b>M Bore diameter (Inches)</b> 1. 0.260 2. 0.385 3. Other									
<b>Special Options</b> 0 - Standard									





Style 1

Van Stone Type

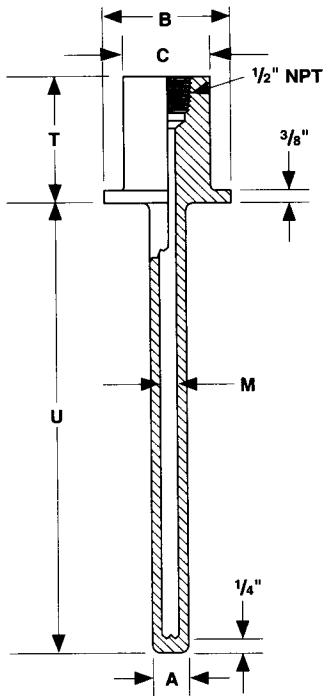

Style 2

Welded Flange Well

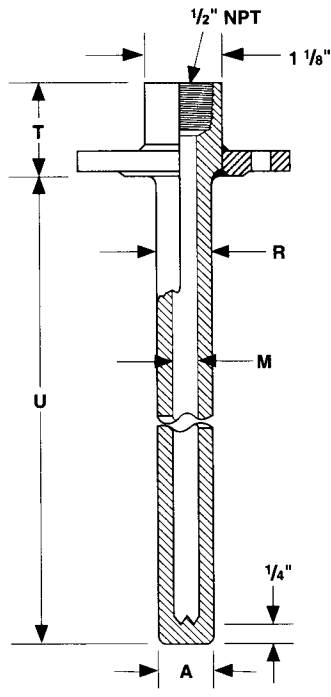

Style 3

Socket Weld Type

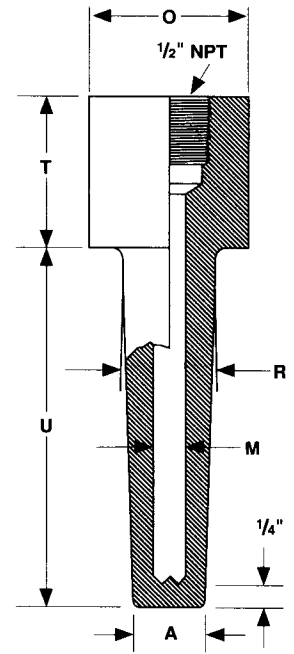

Style 4

Weld-In Type

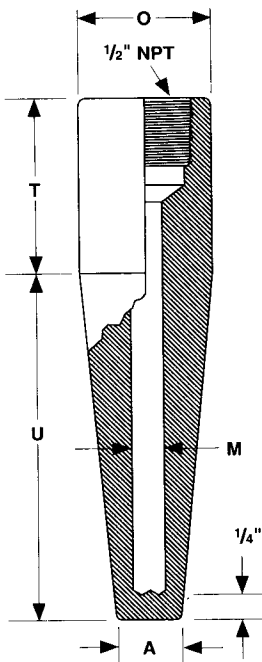

Style 5

Bimetallic Thermometer Wells-Threaded Type

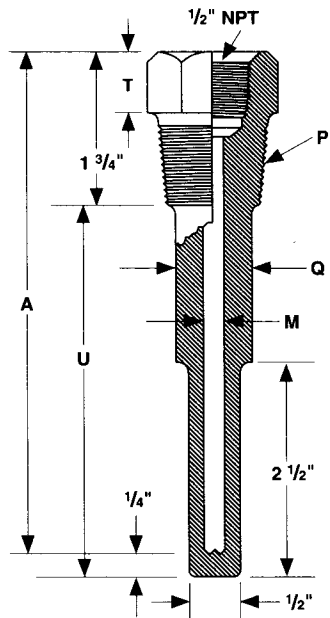

Style 6

Bimetallic Thermometer Well-Flanged Type

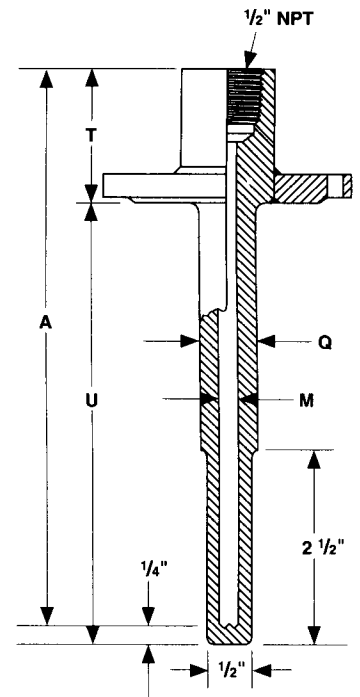

# TEMPERATURE PROBE WITH EYELET

# חיישן טמפרטורה למדידות שטח עם תפיסה ע"י בורג

הגדרת דגם להזמנה - ORDERING CODE

T7

<b>Sensor Type</b> K, J, T, E	סוג הרגש
<b>Sensor Length - mm</b>	אורך הרגש
<b>Hole Diameter</b>	קוטר החור
<b>Cable Type</b> 1. Fiberglass 2. Fiberglass with s.s overbraid 3. Teflon	סוג הכבל
<b>Connection</b> 1. Standard Plug 2. Standard Jack 5. Mini Plug 6. Mini Jack 7. None	סוג החיבור

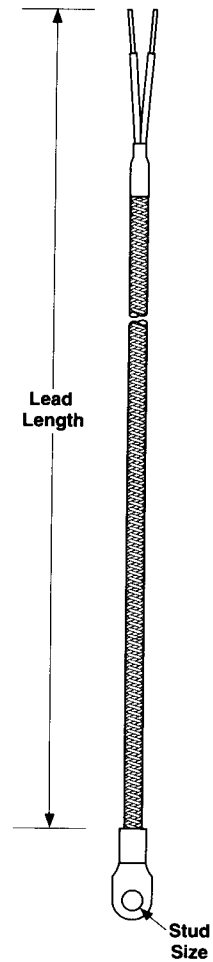

# PIPE CLAMP THERMOCOUPLE

# חיישן טמפרטורה עם טבעת הידוק לצנרת

הגדרת דגם להזמנה - ORDERING CODE

T8

<b>Sensor Type</b> K, J, T, E	סוג הרגש
<b>Sensor Length - mm</b>	אורך הרגש
<b>PIPE Diameter</b>	קוטר הצינור
<b>Cable Type</b> 1. Fiberglass 2. Fiberglass with s.s overbraid 3. Teflon	סוג הכבל
<b>Connection</b> 1. Standard Plug 2. Standard Jack 5. Mini Plug 6. Mini Jack 7. None	סוג החיבור

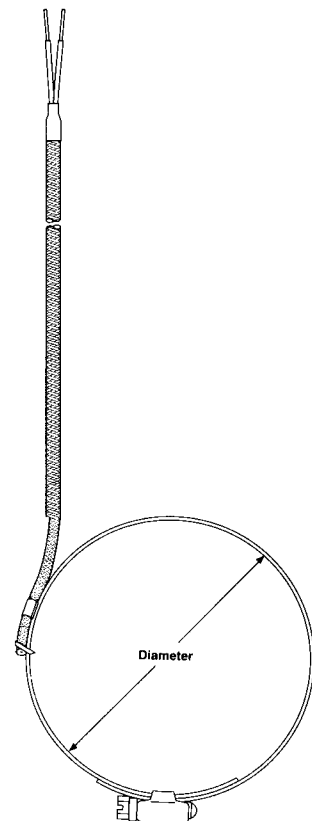

**M.R.C. LTD.**

TEL. 03-5593105, 03-5595252, Fax. 03-5594529

# INSULATED THERMOCOUPLE & COMPENSATING CABLES חוטי טרמוקופל מבודדים וכבלי השוואה לטרמוקופל

הגדרת דגם להזמנה - ORDERING CODE

TC

**Thermocouple Type** סוג הטרמוקופל  
 K, J, T, R, S, N, E

**Insulation** סוג הבידוד

1. PVC (105°C)
2. PVC Extension grade
3. PVC Shilded
4. Teflon FEP (260°C)
5. Teflon TFE (204°C)
6. Fiberglass (480°C)
7. Silica (980°C)
8. Fiberglass Overbraid (480°C)

**Wire Diameter (B & S Gauge)** קוטר  
 חוט בודד גלוי

20-0.813 mm  
 24-0.508 mm  
 30-0.254 mm  
 XX - Others



טרמוקופל מבודד PVC - עד 105°C

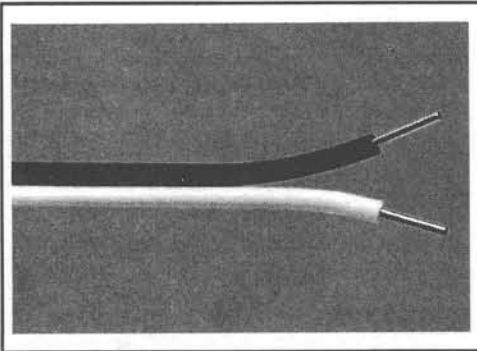

טרמוקופל מבודד טפלון - עד 260°C

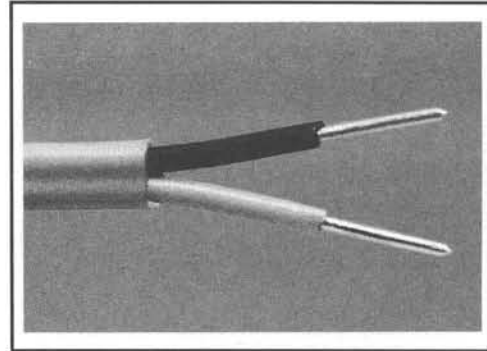

טרמוקופל מבודד סיבי זכוכית - עד 480°C

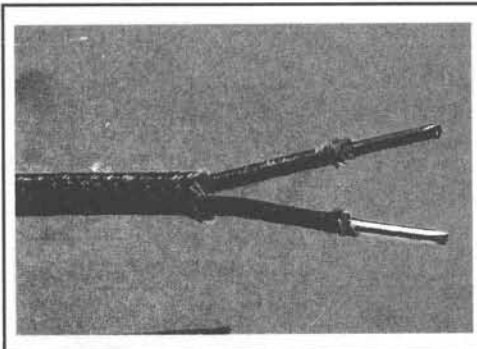

טרמוקופל מבודד סיליקה - עד 980°C

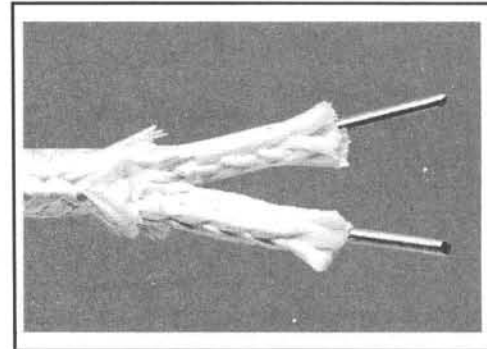

**M.R.C. LTD.**

TEL. 03-5593105, 03-5595252, Fax. 03-5594529

# THERMOCOUPLE CONNECTORS

## מחברים ואביזרים לטרמוקופלים

הגדרת דגם להזמנה - ORDERING CODE

### STANDARD

Type 10SC

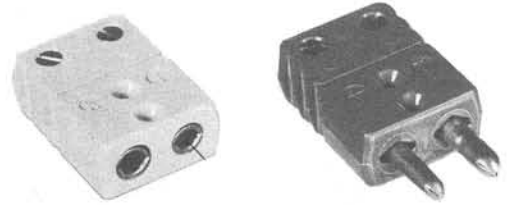

### JAB-IN

Type 10JC

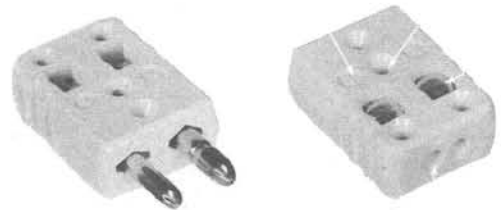

### MINI

Type 10MC

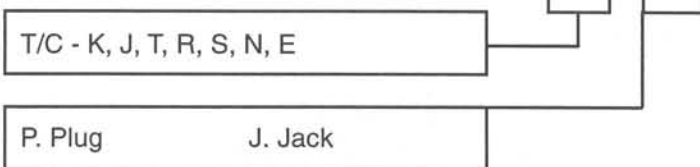

### STRIP PANEL

Type 10SP

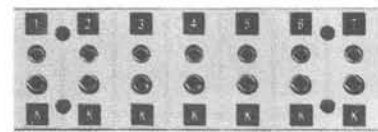
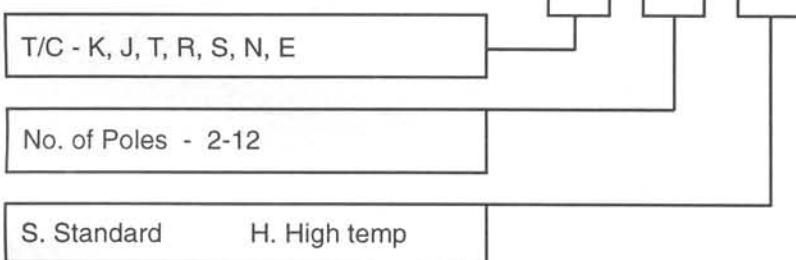

### Cable Clamps תופסן לכבל

10CCM (Mini)      10CCS (Standard)



### Panel Adaptors מתאם לפנל

10PAM (mini)      10PAS (Standard)



**M.R.C. LTD.**

TEL. 03-5593105, 03-5595252, Fax. 03-5594529

# HAND HELD TEMPERATURE PROBES

M.R.C. LTD.

## גששי טמפרטורה ניידיים

### Wire Probe גשש חוט

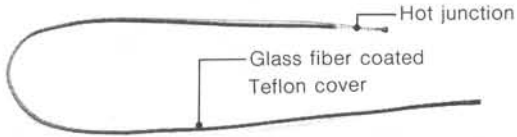

Max. Temp.	Accuracy	Response time
260°C	±0.3% of reading ±1°C	0.1sec.(63%)
210°C		0.3sec.(99%)
500°C		

### Liquid Probe גשש לטבילה בנוזל



Diameter of needle	length	Max. Temp.	Accuracy	Response time
app. φ3	100mm	200°C	±0.4% of Reading ±1°C	2sec.(63%)
app. φ4	300mm	200°C		20sec.(99%)

●Plating liquid, developing liquid, waste water, and other chemical liquid.

### Air Probe גשש לאויר



Max. Temp.	Accuracy	Response time
500°C	±0.3% of reading ±1°C	0.1sec.(63%) 0.3sec.(99%)

### Needle Probe גשש דקירה



●Soft rubber, frozen foods, asphalt, oil, engine exhaust, and other liquid or semi-solids.

Max. Temp.	Accuracy	Response time
500°C	±0.3% of Reading ±1°C	0.3sec.(63%) 3sec.(99%)

### Soft Body Probe For Animal גשש לבעלי חיים

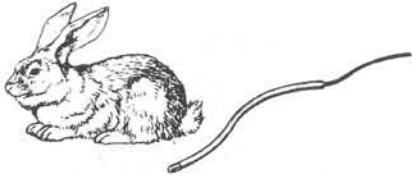

sensor is suitable for small animal rectum temperature.

Body diameter	Max. Temp.	Accuracy	Response time
φ3	200°C	±0.5% of Reading ±1°C	0.5sec.(63%)
φ4			4sec.(99%)

### Soldering Iron Probe גשש לראש של מלחם

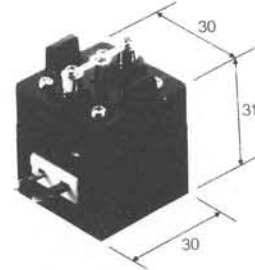

Max. Temp.	Accuracy	Response Time
500°C	±1% of Reading ±1°C	0.1sec.(63%) 2.0sec.(99%)

### Probe for Molten metal גשש לבדיל מותר



● Molten solder and other electric conductive molten materials.

Max. Temp.	Accuracy	Response time
700°C	±0.5% of reading ±1°C	0.4sec.(63%) 2sec. (99%)

### Heavy Duty for Molten Metal (Non Ferrous) גשש ליציקות אלומיניום ופליז

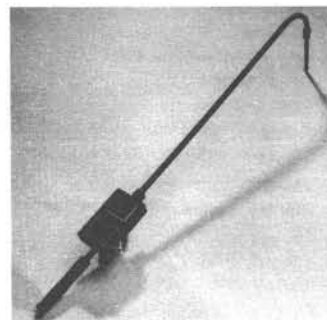

**Hypodermic Needle Thermocouple**  
 גשש דקירה דק

**Aircondition Temperature Probe**  
 גשש לתליה בחדר לבקרת מיזוג אויר

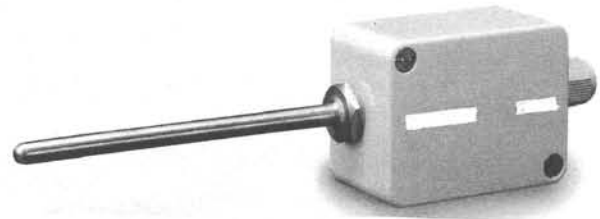

Designed to measure the inside for long time.  
 Diameter of needle is 0.5mm.

210°C	±0.2% of Reading ±1°C	0.2sec.(63%) 0.5sec.(99%)	C
-------	-----------------------	------------------------------	---

- INTEGRATED PT-100 & TRANSMITTER
- ACCURACY OF 0.1%
- TWO WIRE TRANSMITTER
- 4-20MA OUTPUT CURRENT

**HAND HELD SURFACE THERMOCOUPLE PROBE**  
**חיישני טמפרטורה ניידים למדידת שטח**

הגדרת דגם להזמנה - ORDERING CODE

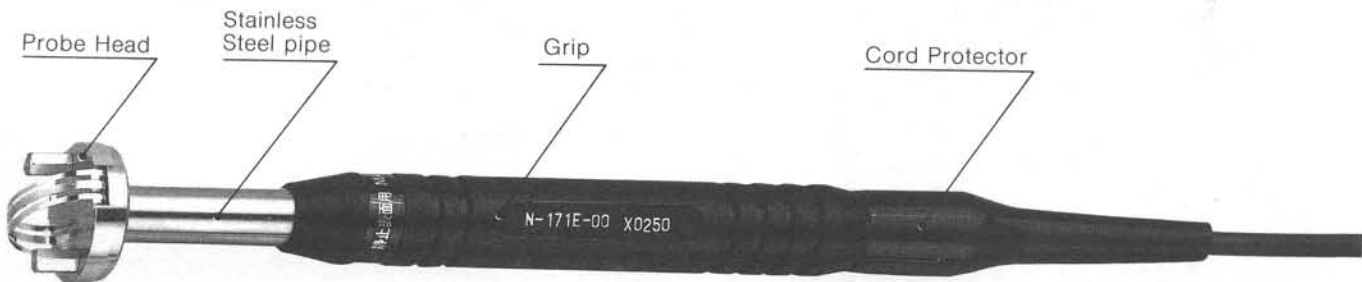
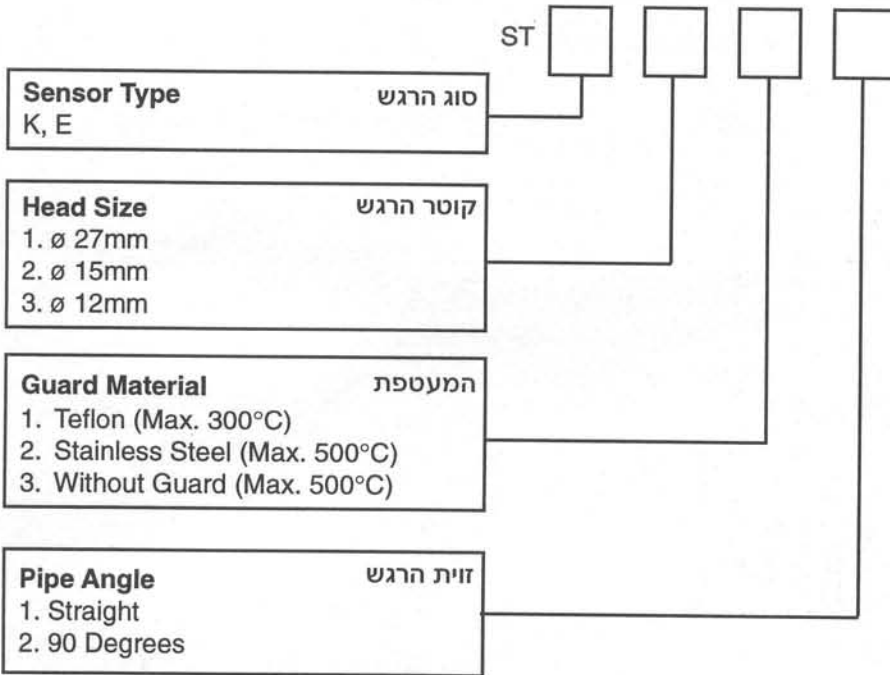

**M.R.C. LTD.**

TEL. 03-5593105, 03-5595252, Fax. 03-5594529

# SPECIAL HAND HELD SURFACE TEMPERATURE PROBE

## חיישני טמפרטורה ניידים מיוחדים למדידות שטח

### Micro Sensor

גשש למדידת טמפרטורה של רכיבים קטנים



This probe is widely used to measure temperature of electronic components and machinery parts and so forth. Head size is  $\phi 6\text{mm}$ .

Max. Temp.	Accuracy	Response time
500°C	$\pm 0.5\%$ of Reading $\pm 1^\circ\text{C}$	0.2sec.(63%) 2.4sec.(99%)

### Magnet Probe

גשש עם תפיסה ע"י מגנט

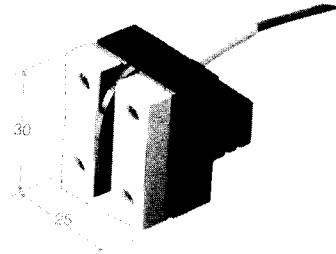

This probe has built-in powerful magnet in Teflon guard. Suitable contact pressure is given by magnetic force.

Max. Temp.	Accuracy	Response time
250°C	$\pm 0.3\%$ of Reading $\pm 1^\circ\text{C}$	0.2sec.(63%) 2sec.(99%)

### Pipe Outside Probe

גשש לצנרת



- Heat pipe, oil pipe, gas pipe, ventilator pipe, cooling pipe, other pipe surfaces.

This probe is manufactured the most suitable teflon guard to the diameter of pipe by customer's request.

Max. Temp.	Accuracy	Response time
250°C	$\pm 0.4\%$ of Reading $\pm 1^\circ\text{C}$	0.2sec.(63%) 2sec.(99%)

### High Temp. Probe - 1200°C

גשש שטח לטמפרטורה גבוהה

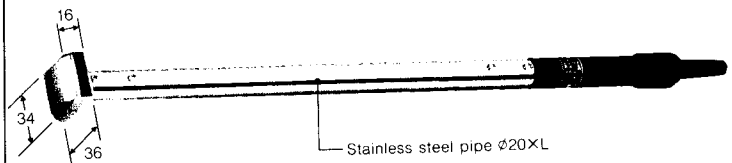

Probe Head is protected by thin stainless steel plates for high temperature measurement.

Max. Temp.	Accuracy	Response time
1200°C	$\pm 1\%$ of Reading $\pm 1^\circ\text{C}$	3sec.(63%) 15sec.(99%)

### Moving Probe

גשש למשטחים וגלילים נעים

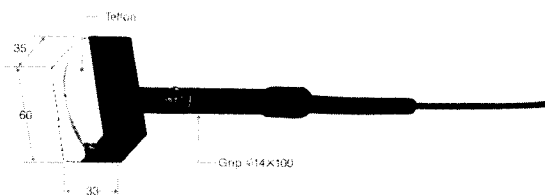

For measuring the temperature of moving or stationary smooth flat surfaces.

Maximum service surface speed: 800m/min.

- Glue roller, electric ironing machine, coilder and heat roller surfaces.
- Paper, steel plate, ingot and other moving surfaces.

Max. Temp.	Accuracy	Response time
250°C	$\pm 0.3\%$ of Reading $\pm 1^\circ\text{C}$	0.4sec.(63%) 2.0sec.(99%)

### Rolling Wheel Probe

גשש עם גלגליות למשטחים וגלילים נעים

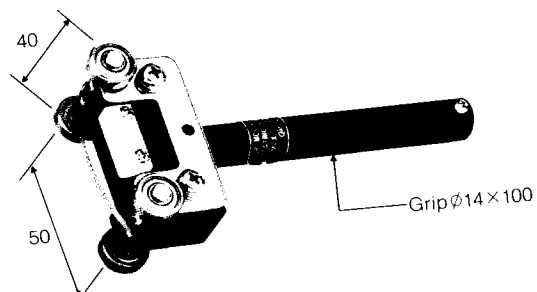

- Heat rollers, electric ironing machines, conveyer belts, paper, and other moving surfaces.

Four roller bearings are used instead of Teflon guards. Maximum velocity of moving surfaces should not exceed 500m/min.

Max. Temp.	Accuracy	Response time
200°C	$\pm 0.3\%$ of Reading $\pm 1^\circ\text{C}$	0.5sec.(63%) 3sec.(99%)